

4

3

2

1

A

B

C

D

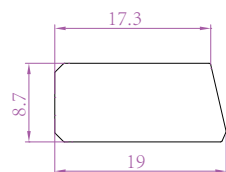
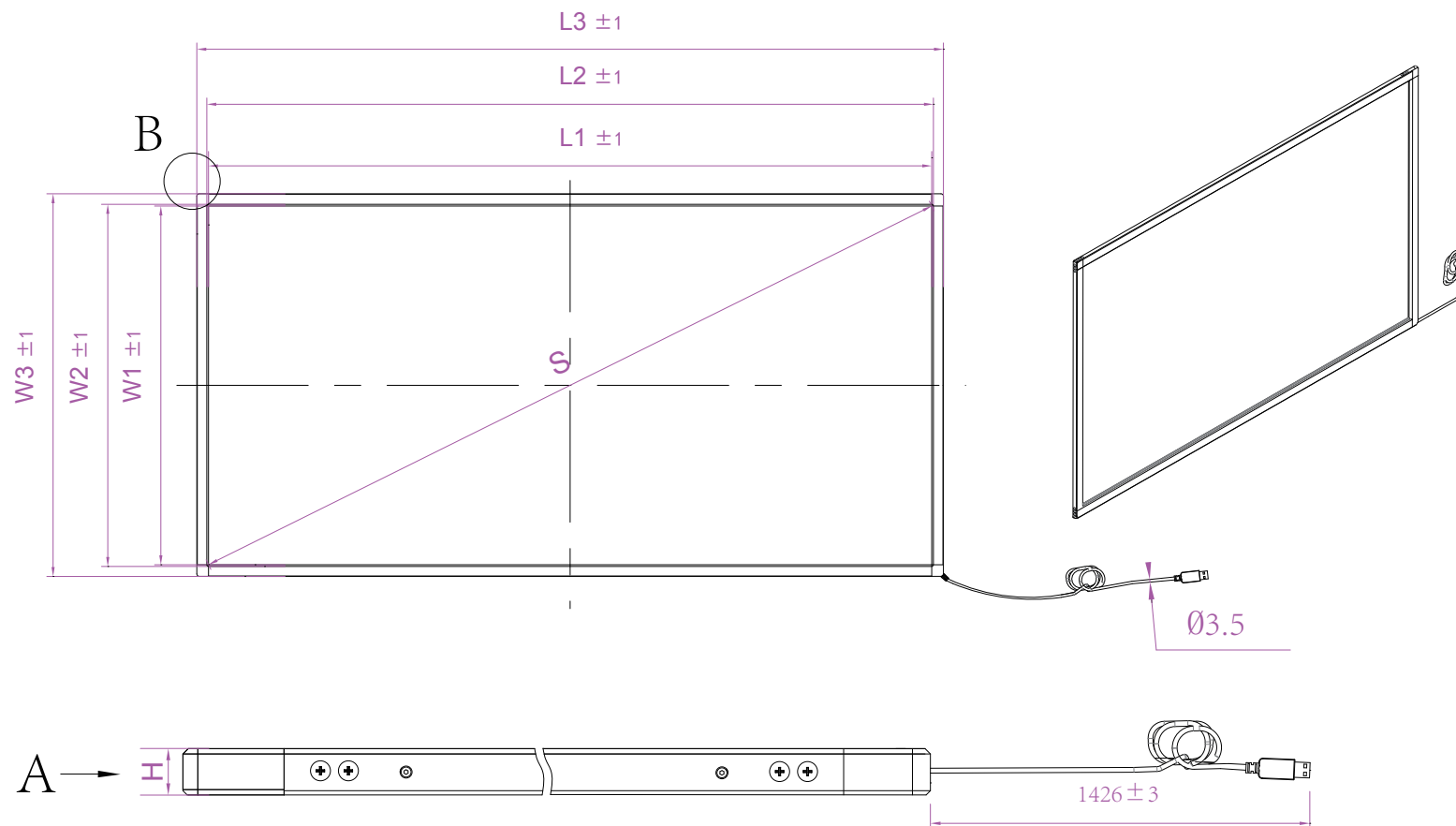
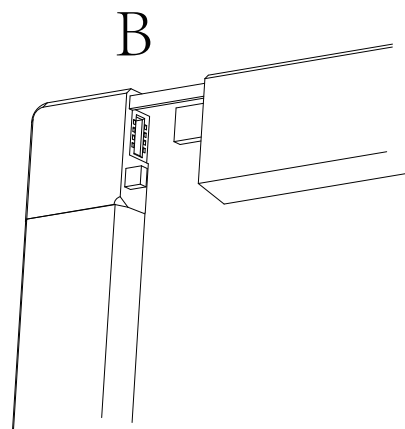

A

S(Inch/mm)	80.23"/2038.03
W1	998.1 ± 1
W2	1001.5 ± 1
W3	1036.1 ± 1
L1	1776.9 ± 1
L2	1780.3 ± 1
L3	1814.9 ± 1
H	8.7 ± 0.2



Anti-Sunlight, No Blind Zone For Any Size



X Slim Series							
Material:	plastic	Unit:	mm	Date:		Rev:	1.0
Draft by:				Approved by:			

4

3

2

1